

H605B说明书

版本:2.0

料号:807-0003-00342

折叠尺寸:105×145 (mm)

展开尺寸:210×145 (mm)

材质:80G书页纸

工艺:单色印刷

折叠方式:骑马钉



User Manual



Govee
RGBICWW
TV Light Kit with Camera
Model: H605B

Safety Instructions

Read and follow the safety instructions below:

- This product is not waterproof. Avoid exposing its components to splashes, water drops, or every high-humidity environments.
- Be careful of static electricity during installation and usage and keep away from sharp objects and strong corrosive chemicals.
- When bending the strip light during installation, avoid folding the LED strip light component as this may affect its lifespan.
- Remove nails, metal, or other conductive objects on the installation surface before attaching the strip light in order to avoid short circuits.
- The internal light sources of the light bars and strip light cannot be replaced. If the light sources sustain damage, the product should be replaced.
- Do not let children install the light bars or strip light alone.
- External dimmers cannot be used with this product.
- Avoid installing this product near major heat sources.
- Avoid installing the light bars near potentially dangerous sources (e.g., candles, liquid-filled objects.)

Introduction

Thanks for choosing Govee RGBICWW TV Light Kit. The ColorSense Camera in this kit can automatically detect the colors onscreen and project them on the wall behind via the light bars and strip light. This real-time effect syncs perfectly with your movies, TV shows, sports, and gaming worlds, bringing another level of immersive experience to your entertainment. Govee RGBICWW TV Light Kit also supports intelligent voice control for hands-free access to your entertainment lighting.

What You Get

Light Bars	2
Light Strip	1
Control Box	1
Camera	1
Power Adapter	1

Light Bar Mounting Stands	2
Foam Stickers	8
Light Strip Clips	8
User Manual	1
Service Card	1

At a Glance

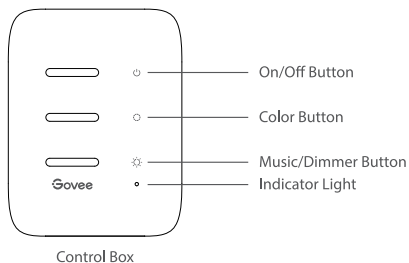

On/Off Button	Press to turn On/Off.
Color Button	Press to change the color.
Music/Dimmer Button	Press to enter Music mode.
Button	Long press to adjust the brightness.
Indicator Light	<ul style="list-style-type: none"> a. Red light indicates the device is not connected to the Wi-Fi network. b. Blue light indicates the device has successfully connected to the Wi-Fi network. c. No light indicates the device is not powered on or might be broken.

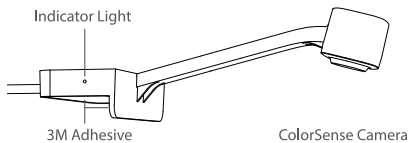

Indicator Light

- a. Blue light indicates the camera is powered on.
- b. Dim light indicates the camera is not powered on or might be broken.

Installing Your Device

Installation Steps

- a. Wipe the surface the strip light will be installed on to ensure it is dry and clean.

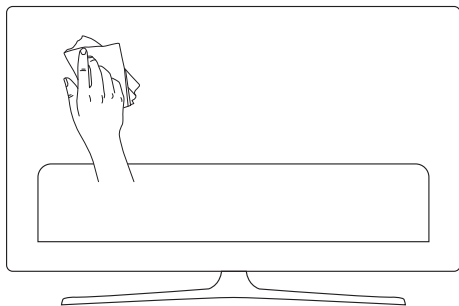

- b. Stick the strip light to the back of the TV. Press firmly for a few seconds to ensure a secure attachment. Reinforce using the provided clips.

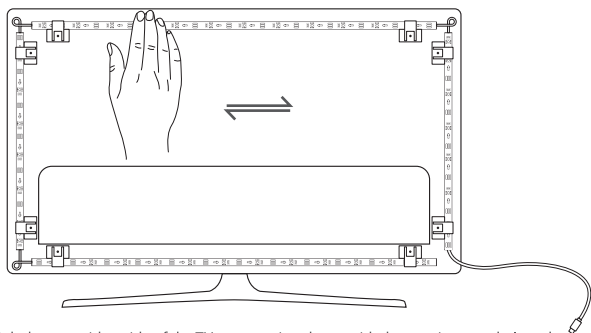

- c. Place the light bars on either side of the TV screen using the provided mounting stands. In order to achieve the best lighting effect, the two bars should be in line with the screen and about 20 inches (50cm) to either side.

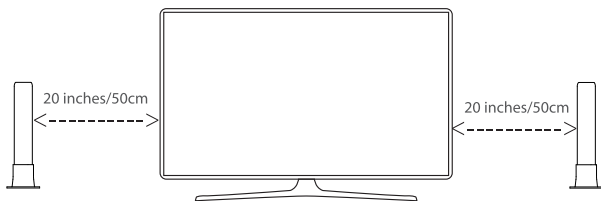

- d. Position the camera top-center of the screen looking down, or bottom-center of the screen facing up.

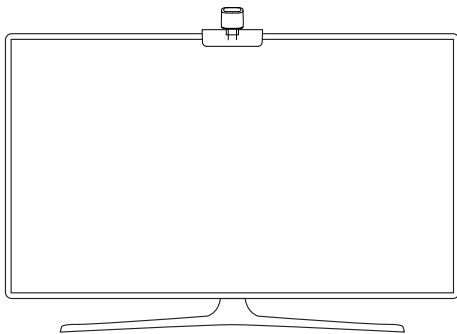

- e. Insert the light bars and strip light cables (Type-C), and camera cable (USB) into the corresponding control box ports.

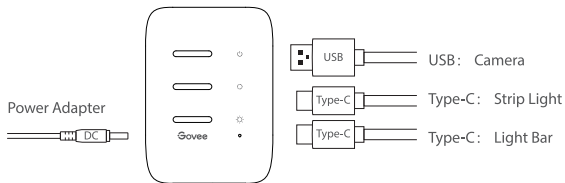

- f. Connect the power adapter cable into the control box and then plug in the adapter to a power outlet.
- g. Installation should now be complete!

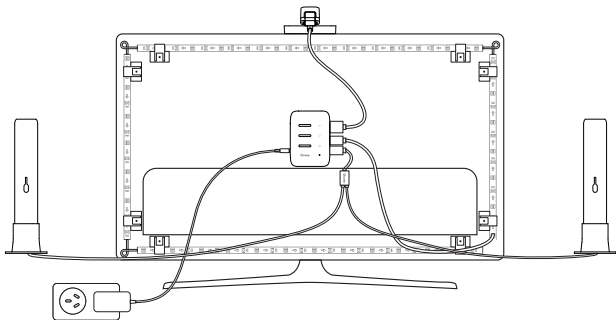

Pairing Your Device with Govee Home App

What you need:

- A Wi-Fi router supporting the 2.4GHz and 802.11 b/g/n bands. 5GHz is not supported.
- ① Download Govee Home App from the App Store (iOS) or Google Play (Android).



- ② Use a smartphone connected to your home 2.4Ghz Wi-Fi network (5Ghz is not supported).
- ③ Open Govee Home App, tap the "+" icon in the top right corner and search for "H605B".
- ④ Tap the device icon and follow the onscreen instructions to complete pairing.

Calibrating the Camera Using Govee Home App

- a. Ensure the camera is positioned at the top-center or bottom-center of the screen.

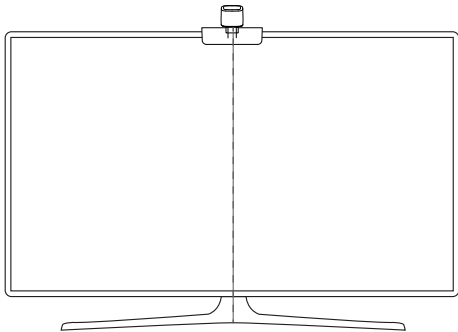

- b. Gently place the provided foam stickers to the 7 position points on the screen as shown in the image here.

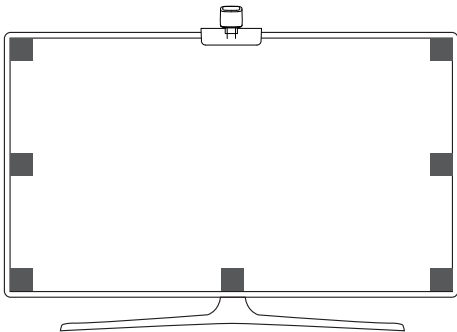

c. Open Govee Home App, go to the Settings page, then tap "Calibration". Begin calibration by following the instructions shown in the App.

Tips:

- Drag the position points in the calibration image to the foam stickers located on the screen.

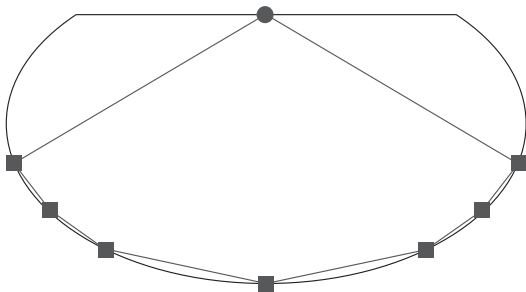

● Camera ■ Position Points

- The image may be warped due to the nature of the fish-eye camera. Make sure the calibration points match up correctly. Note that the calibration lines should not overlap or cross.

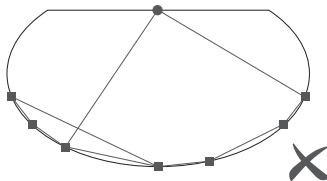
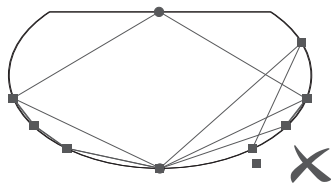
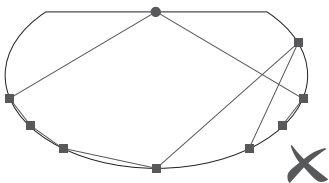

Specifications

Working Voltage	AC 100 - 240V
Input	12V 3A
Brightness	400lm
Color	RGBICWW
Color Temperature	2200K-6500K
Camera Resolution	1080P
Working Temperature	-10°C to 40°C/-14°F to 104°F

Troubleshooting

❶ Cannot connect to Wi-Fi.

- Check if the camera is powered on. A blue light will indicate the camera is on and functioning correctly.
- Do not skip connecting to Wi-Fi during pairing process.
- Ensure your Wi-Fi router is 2.4GHz capable (5GHz is not supported).
- Ensure you entered the correct Wi-Fi password during the Wi-Fi connection process.
- Use another smartphone to pair with the device to check if your Wi-Fi network is working.
- Shorten the distance between the device and the Wi-Fi router to less than 50ft, then try reconnecting.

❷ In video mode, the light color is not consistent with the color onscreen.

- Ensure there are no strong external light sources interfering with the camera.
- Ensure the camera is installed at the top-center or bottom-center of the screen.
- Calibrate the camera again by following the instructions previously provided.

❸ Calibration has failed.

- Check the stability of the Wi-Fi connection. A stable connection is required for successful calibration.
- Follow the app instructions to calibrate.

- 4 Cannot pair or connect with Alexa or Google Assistant.
 - Ensure the stability of the Wi-Fi connection.
 - Go to the app Settings page and follow the instructions under “User Guide” to pair the device again.
- 5 The synchronization effect for Music mode is not working properly.
 - Ensure the control box is close to the music source, which will help the mic pick up sounds better.
 - Also try switching the mic source to the smartphone.
- 6 The adhesive is not sticking properly.
 - Wipe the installation surface fully to ensure it is dry and clean.
 - Do not press with exertion when sticking the foam sticker. To avoid possible damage to the TV screen, make sure to peel it off from the side after use.
- 7 Only one user can control the device.
 - Each device can only be controlled by one account.
 - If multiple users wish to control the same device, ensure they are using the same account.

Customer Service

 Warranty: 12-Month Limited Warranty

 Support: Lifetime Technical Support

 Email: support@govee.com

 Official Website: www.govee.com

 @Govee  @govee_official  @govee.official

 @Goveeofficial  @Govee.smarthome

FCC and ISED Canada Statement

This device complies with Part 15 of the FCC Rules and Industry Canada licence-exempt RSS standard(s). Operation is subject to the following two conditions:

- (1) This device may not cause harmful interference, and
- (2) This device must accept any interference received, including interference that may cause undesired operation.

Warning: Changes or modifications not expressly approved by the party responsible for compliance could void the user's authority to operate the equipment.

Le présent appareil est conforme aux CNR d'Industrie Canada applicables aux appareils radio exempts de licence. L'exploitation est autorisée aux deux conditions suivantes :

- (1) l'appareil ne doit pas produire de brouillage, et
- (2) l'utilisateur de l'appareil doit accepter tout brouillage radioélectrique subi, même si le brouillage est susceptible d'en compromettre le fonctionnement.

NOTE: This equipment has been tested and found to comply with the limits for a Class B digital device, pursuant to Part 15 of the FCC Rules.

These limits are designed to provide reasonable protection against harmful interference in a residential installation. This equipment generates uses and can radiate radio frequency energy and, if not installed and used in accordance with the instructions, may cause harmful interference to radio communications. However, there is no guarantee that interference will not occur in a particular installation. If this equipment does cause harmful interference to radio or television reception, which can be determined by turning the equipment off and on, the user is encouraged to try to correct the interference by one or more of the following measures:

1. Reorient or relocate the receiving antenna.
2. Increase the separation between the equipment and receiver.
3. Connect the equipment into an outlet on a circuit different from that to which the receiver is connected.
4. Consult the dealer or an experienced radio/TV technician for help.

This Class B digital apparatus complies with Canadian ICES-005.
Cet appareil numérique de la classe B est conforme à la norme NMB-005 du Canada.

The Bluetooth® word mark and logos are registered trademarks owned by Bluetooth SIG, Inc. and any use of such marks by Shenzhen Intellirocks Tech. Co., Ltd. is under license.

Govee is a trademark of Shenzhen Intellirocks Tech. Co., Ltd.
Copyright ©2021 Shenzhen Intellirocks Tech. Co., Ltd. All Rights Reserved.

FCC and IC Radiation Exposure Statement

This equipment complies with FCC and IC radiation exposure limits set forth for an uncontrolled environment. This equipment should be installed and operated with minimum distance 20cm between the radiator & your body.

la distance entre l'utilisation et l'appareil ne doit pas être inférieure à 20 cm.

This device uses a non-replaceable light source. When the light source reaches the end of its life cycle, this device should be replaced. Not intended for illumination. Only used for creating ambiance.

- 1.Do not connect the rope light to the supply while it is in the packing or wound onto a reel;
- 2.Do not use the rope light when covered or recessed into a surface;
- 3.Do not open or cut the rope light;

Responsible party :

Name: GOVEE MOMENTS(US) TRADING LIMITED

Address: 13013 WESTERN AVE STE 5 BLUE ISLAND IL 60406-2448

Email: support@govee.com

Contact information: <https://www.govee.com/support>



FOR INDOOR USE ONLY

POUR UNE UTILISATION EN INTÉRIEUR UNIQUEMENT

CAUTION:

RISK OF EXPLOSION IF BATTERY IS REPLACED BY AN INCORRECT TYPE.

DISPOSE OF USED BATTERIES ACCORDING TO THE INSTRUCTIONS.

ATTENTION :

RISQUE D'EXPLOSION SI LA BATTERIE EST REMPLACÉE PAR UN TYPE

INCORRECT. ÉLIMINER LES BATTERIES USÉES CONFORMÉMENT AUX

INSTRUCTIONS.



Govee Home App

For FAQs and more information,
please visit: www.govee.com